

Improving Torque and Speed of Joints by Using Rod-and-Lever Systems for Electrically Driven Humanoid Robots

Manuel Scharffenberg¹, Ulrich Hochberg¹, Klaus Dorer¹, André Friedrich¹, Michael Wülker¹

Abstract—Autonomous humanoid robots require light weight, high torque and high speed actuators to be able to walk and run. For conventional gears with a fixed gear ratio the product of torque and velocity is constant. On the other hand desired motions require maximum torque and speed. In this paper it is shown that with a variable gear ratio it is possible to vary the relation between torque and velocity. This is achieved by introducing systems of rods and levers to move the joints of our humanoid robot "Sweaty II". On the basis of a variable gear ratio low speed and high torque can be achieved for those joint angles, which require this motion mode, whereas high speed and low torque can be realized for those joint angles, where it is favorable for the desired motion.

I. INTRODUCTION

Since 2002 humanoid robots participate in the RoboCup competition. The size and weight of the robots increases from the KidSize to the TeenSize and AdultSize leagues [1]. All robots of the TeenSize and AdultSize league, which participated in the RoboCup 2015 competition, were equipped with electrical servo actuators (see Table I).

TABLE I

MOTORS USED IN THE HUMANOID TEENSIZe AND ADULTSIZe CLASSES AT ROBOCUP 2015 [2]

TeenSize class	
AcYut	Dynamixel MX-106, -64, -28
AUT-UofM	MX-106, -64, -28
HuroEvolutionTN	MX-106, -64, -28
Nimbro	MX-106, -64
MU-L8	MX-106, -64
Parand	MX-106, -64, -28
WF Wolves Taura Bots	MX-106, -64
AdultSize class	
Baset	MX-106, -64, -28
BehRobot	MX-106, RX-64, AX-12
CIT Brains	Vstone SV3300, -310, RX-28
Huro Evolution	MX-106, -28
Robo-Erectus	Kondo KRS-6003HS, -HV
THORwIn	Dynamixel H54-200-S500-R
Tsinghua-Hephaestus	Vstone V3310, EX106+

These servo drives have a several advantages. They are of relatively light weight, allow a simple mechanical design and typically provide a large range of angles for the joints. On the other hand, these servo motors are not powerful enough to provide high torque and high speed in light weight designs. Gears can be used to find a balance between torque and speed, but increased weight and a fixed gear ratio

must be their drawbacks. This is reflected by the four-fold constraint scenario of mechanical designs shown in Figure 1. An optimal actuator should be fast, powerful, long-lived and light-weight.

Another disadvantage of the servo motors described in Table I is, that they are typically mounted so that the joint is an integral part of the servo motor. The full weight of the robot is then pushing on the gears causing excessive wear and tear. A further disadvantage is that the operating point of the motor is always located at a single point inside the square of the four-fold mechanical design constraints.

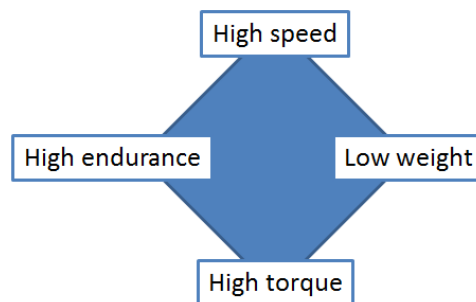

Fig. 1. Four-fold mechanical constraint scenario

Other robots like the Atlas robot [3] use indirect actuation, at least for the legs. The motors push or pull rods and the mechanical structure turns this linear movement into a rotation around the desired joint. The advantage of this approach is that it allows for variable torque and speed. Properly designed, the joint will operate at high torque in typical movement phases that require high torque and vice versa at high speed in phases that require high speed. However, to get enough power the Atlas robot uses a hydraulic system, which is relatively complex and expensive.

In this paper an actuator and mechanical design is proposed that uses indirect actuation based on electrical motors. The ultimate goal is to achieve dynamic walking and running.

Our first robot "Sweaty I", which participated in the RoboCup 2014, is therefore mechanically redesigned and improved. For the optimization of the mechanical structure, especially concerning the range of angles and angular speeds required, the KIT Whole-Body Human Motion Database [4] with the framework provided by Terlemez et al. [5] was used.

One advantage of indirect actuation is that ball screws can be used, as for example demonstrated by the humanoid robot Lola [6]. The result is a humanoid robot with a high power to weight ratio, but relatively low power consumption.

This paper is organized as follows: In Section II robots

¹Hochschule Offenburg, Badstr. 24, 77652 Offenburg, Germany
{mscharff}@stud.hs-offenburg.de, {Ulrich.Hochberg,
Klaus.Dorer, Andre.Friedrich, Wuelker}@hs-offenburg.de

with rod-and-lever systems are shortly described. Section III relates to an analysis of motion capture data and the mechanical requirements to realize selected gaits from the Human Motion Database. Section IV suggests different rod-and-lever systems and Section V summarizes the implications for the mechanical design of the new robot Sweaty II.

II. RELATED WORK

The idea of using rod systems for walking machines is quite old. Ryoo [7] describes a mechanical horse, which he thinks is able to walk. The idea of transforming rotational movements into longitudinal movements is illustrated in Figure 2. It is not reported, whether the energy recovery by several springs X was sufficient, so that a strong man could ride and balance the horse at the same time.

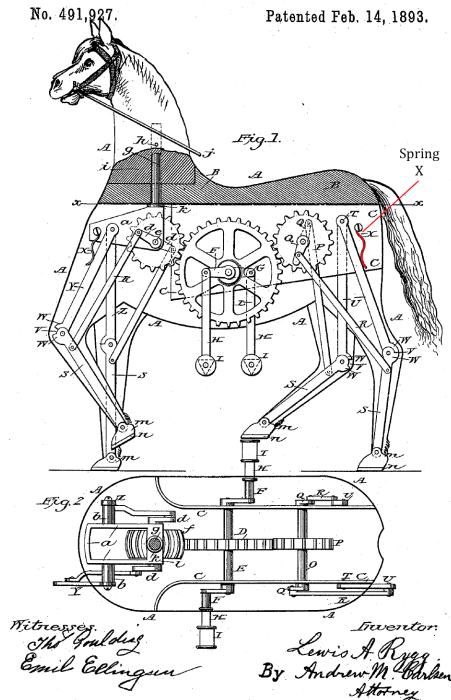

Fig. 2. Mechanical horse [7]

Lola, the humanoid robot from the Technical University of Munich, successfully uses a system consisting of spindle motors and rod systems for the feet and knees. In this configuration Lola was able to walk and potentially run. This humanoid is approximately twice as heavy as Sweaty II and uses stronger motors. It is described in detail in [6], [8].

The Atlas robot from Boston Dynamics [3] is at the moment one of the most advanced humanoid robots. As can be seen in photographs and videos the actuation for the feet and knees is realized by hydraulically driven rod systems. The hip seems also to be driven hydraulically, but directly actuated without a rod-and-lever system.

III. ANALYSIS OF MOTION CAPTURE DATA

In order to properly choose and design the mechanics of the rod system, one needs to know the range of angles and angular velocities required. This has been achieved by

analyzing human motions by video capture. The KoroiBot project [4] provides a motion database to document human motional behavior. The database contains a lot of motion data files generated by recording moving people in various situations. The framework also contains a tool to visualize the motions [5]. Figure 3 shows a visualization of medium fast walking.



Fig. 3. Medium fast walk based on motion capture data

Figure 4 shows as an example the corresponding angles and angular velocities of the knee.

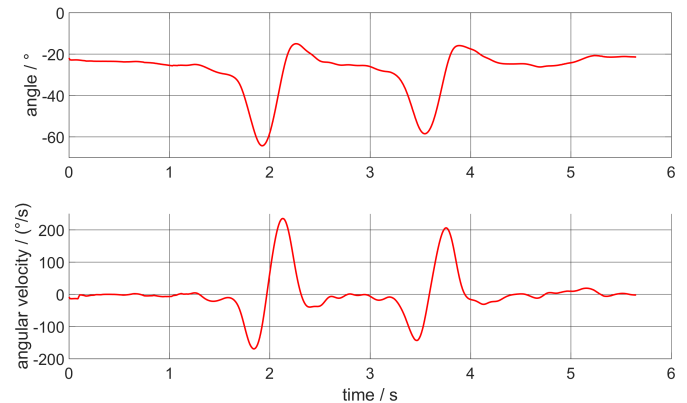

Fig. 4. Motion of the left knee

A subset of the data files has been preprocessed by a team at the Karlsruhe Institute of Technology [4]. Using the concept of a Master Motor Mapper, the capture data can be transformed to a robot model. The result is an xml-file, which provides joint angles as a function of time for each joint of the robot. For a 1-DoF joint a minimum and a maximum angle can then be extracted. For a 2-DoF joint a region of joint angles for human gait is found. A 3-DoF joint results in a three dimensional region.

From the data of the Master Motor Mapper information on angular velocity over time as well as angular velocity as a function of the joint angle can be calculated. To design an actuator, additionally information about the torque

is required, which cannot be extracted directly from the motion database, because it strongly depends on the weight distribution of the robot.

Figures 5 and 6 show data generated by the superposition of 44 different motion files in the categories

- walk slowly, at medium speed or fast,
- turn left or right,
- bend or
- run.

Figure 5 shows 2D-trajectories for the roll and pitch angles of the hip. Each symbol represents a pair of angle values as found in the motion database. It can be seen, that on average a maximum in pitch angle does not coincide with a maximum in roll angle. Therefore, it was decided to design Sweaty II in a way that the two maximum positions do not occur simultaneously. Corresponding three dimensional trajectories are shown in Figure 6 which is an extension of this idea to all three angles.

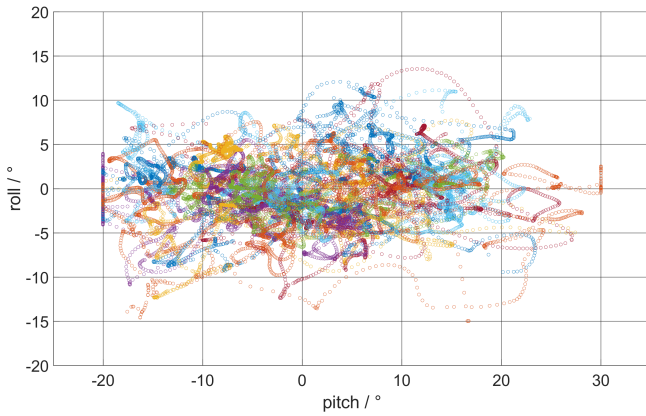

Fig. 5. Density of roll-pitch angle combinations of the hip from different categories of motions

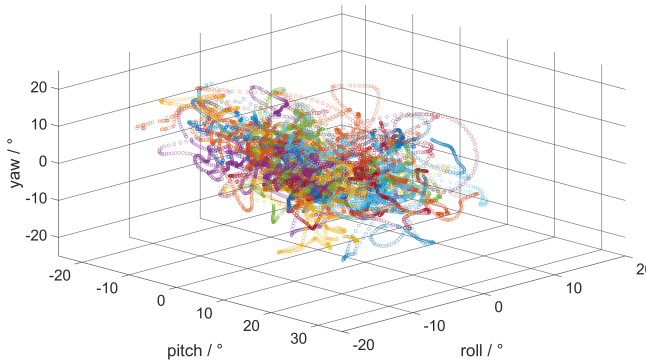

Fig. 6. Trajectories of pitch, roll and yaw angles of the hip for different motions

Since for the knee, being a 1-DoF joint, the situation is less complicated than for the hip, this was first considered for a redesign of Sweaty I. Figure 7 shows the torque estimated from a simple model for the knee (Figure 9) starting from -90° to 5° . For an angle of 0° the knee is stretched and at 5° it is over-stretched. The solid curve describes the static torque

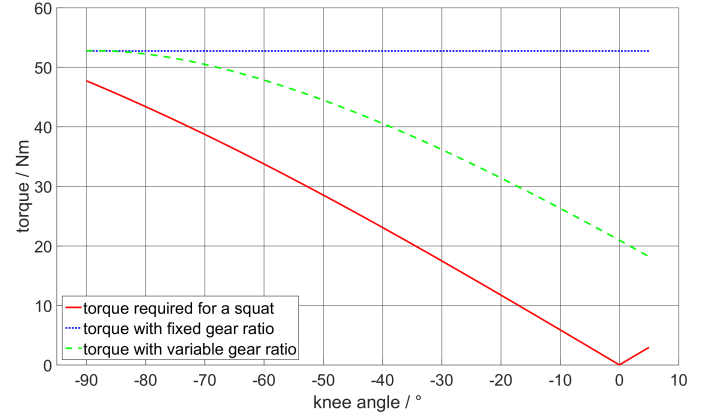

Fig. 7. Torque as a function of the knee angle

M_{squat} , which is needed to do a squat with the redesigned robot Sweaty II. It is calculated by Equation 1 on the basis of the set-up shown in Figure 9, assuming a mass of $m = 20 \text{ kg}$ and a length of the shank L .

$$M_{\text{squat}} = L \cos\left(\frac{\varphi}{2}\right) m g \quad (1)$$

$$F_{\text{screw}} = \frac{2\pi M_{\text{gear}} \eta_{\text{screw}}}{p} \quad (2)$$

$$M_{\text{variable,ratio}} = l \sin(\alpha) F_{\text{screw}} \quad (3)$$

The dashed curve in Figure 7 shows, how much torque a new design with electric drives from maxon motor GmbH (see Section IV) can provide. It was calculated from Equation 3, where l is the length of the lever and α the angle between the ball screw axis and the lever.

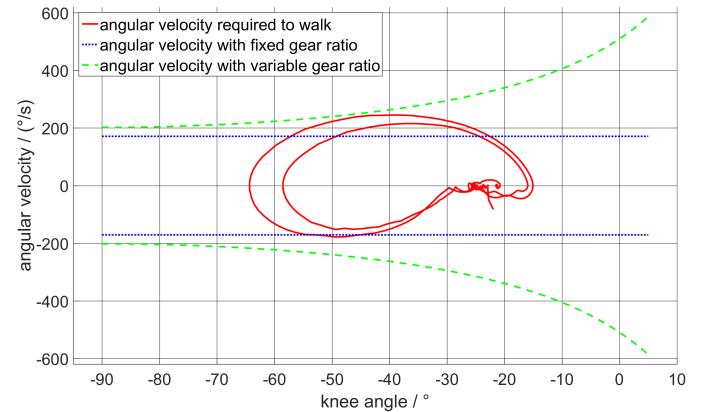

Fig. 8. Angular velocity as a function of the knee angle

Figure 8 compares the angular velocities. The dashed curve shows the angular velocity, which can be achieved with the new design. Equation 4 is used to calculate the attainable angular velocity ω , while applying the force calculated in Equation 2.

$$\omega = \frac{(k_n U_{\text{motor}} - \frac{\Delta n}{\Delta M} \frac{M_{\text{gear}}}{i \eta_{\text{gear}} \eta_{\text{motor}}}) p}{l \sin(\alpha) i} \quad (4)$$

The solid line represents the velocity which is required to make Sweaty II walk. It is taken from the motion capture database [5]. The dotted lines in Figure 7 and 8 represent a motor with a fixed gear ratio of 1:495 attached directly to the axis of the knee.

Comparing Figure 7 with Figure 8 it is obvious that at -90° a high torque corresponds to low angular velocity and vice versa at 0° a low torque provides high angular velocity. This shows the advantage of a variable gear ratio. The two figures demonstrate that the requirement is fulfilled to always have enough torque and angular velocity, where it is needed.

As mentioned earlier, torque values are not directly available from the motion capture database. One way to extract torque data additionally employs a multi-body simulation of the robot. In this case, a model of the robot as well as a contact model between a foot and the ground is required. The torque can then be calculated by using joint angle data over time as an input to the simulation. In such a simulation it is possible that the robot falls down because of a different mass distribution compared to a human being. In this case the joint angles have to be manually adjusted or a controller needs to be implemented to stabilize the robot.

IV. DESIGN OF ROD-AND-LEVER SYSTEMS

Most electrical motors provide high speed and low torque, but humanoid robots need high torque at low speed. Before such drives can be used a gear is needed to reduce angular velocity and increase torque. For practical gears the gear ratio is limited by mechanical aspects. Typical gears achieve a reduction ratio of about 1:20, some special gears like harmonic drive gears up to 1:320. For higher gear ratios a series of gears would be needed. This results in increased backlash and low efficiency. For small robots this is not a big problem since they do relatively small movements and have short legs. Therefore uncontrolled movement due to backlash is typically small. Considering the intercept theorem it is clear that big robots have more problems with backlash.

Another problem with gears in series is their reduced efficiency. But in the context of humanoid robots the most important problem is the increase in weight. A possible solution is using actuators with a better power to weight ratio. This is possible, for example, by temporary overloading motors while providing appropriate cooling [9].

To analyze the option of a rod-and-lever system the principle set-up is shown in Figure 9a. If the knee is almost straight the actuator only needs to provide little torque, but the torque increases with increasing angle of the knee. As mentioned in Section III, in human gait high speed is necessary at least during situations where the knee angles are small. Figure 9b shows a rod-and-lever system for the knee in more detail. The spindle drive provides a rod of adjustable length resulting in a variable transmission ratio. This can be realized advantageously without a big increase in weight.

Figure 10 shows a mechanical prototype of the knee with a variable gear ratio. For better insight some components have been dismantled.

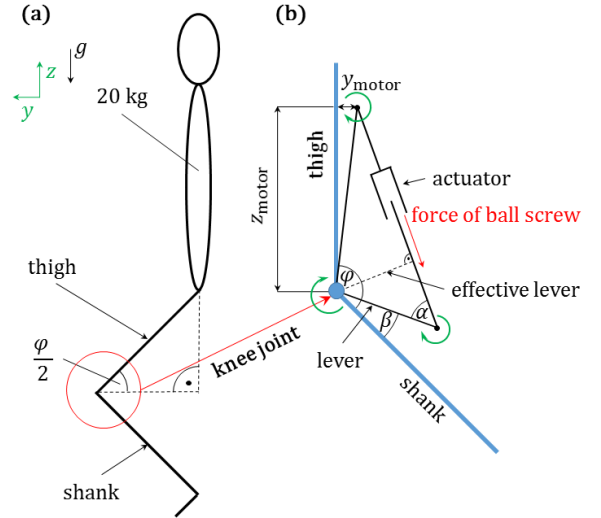

Fig. 9. Genuflexion for a squat. Configuration for the simulation (a) and detail for the rod-and-lever drive of the knee (b)

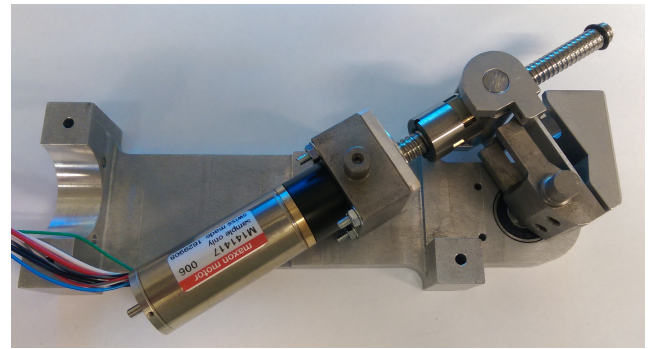

Fig. 10. Mechanical prototype for a rod-and-lever drive for the knee

To be able to overload the motor a motor controller was developed. It can increase and adjust the duty cycle for a short period of time in a way that the motor is overloaded without damage. The actuator is a maxon EC-4-pole motor (type M141417, 323217) with a planetary gear ($i = 1:3.81$, $\eta_{\text{gear}} = 0.84$, maximal $M_{\text{gear}} = 0.8 \text{ N m}$, type 363864) and a ball screw ($p = 2 \text{ mm}$, type KGT-F-8x2). A temperature measurement and a thermal model help to ensure that the motor is not damaged by the thermal overload.

With a constant force of 1508 N (Equation 2), which can be applied for about 6 s without cooling, the torque curve shown in Figure 7 was calculated. Furthermore, the maximum force of the system is calculated as 2470 N for 1.7 s without cooling. This force was verified with a tensile testing machine, the required motor current was as calculated (22 A).

The overall gear ratio with the rod-and-lever system (motor / joint) ranges from about 1:142 up to 1:452. The corresponding angular velocity curve is shown in Figure 8. The angle of the knee is measured directly by a rotary encoder mounted on the joint and indirectly by recording the turns of the spindle with the rotary encoder built into the motor. This approach additionally requires an initial

reference movement.

Considering the maximum torque and angular velocity the motor would need a power of 320 W. With the variable gear ratio of the rod-and-lever system a motor with only 260 W is sufficient. In fact a motor that can continuously only provide 90 W without evaporative cooling was installed. The motor controller deals with this situation of thermal overloading.

In the end the variable gear ratio allowed to reduce the size of the motor and therefore the weight. This is important, because the motors are the heaviest parts of the robot. Disadvantages of the rod-and-lever system are a more elaborate mechanical design and more complicated calculations by the motor controller. The mechanical design requires additional joints, levers and rods.

A. *Sweaty I*

The rod-and-lever design was already used for the adult size robot *Sweaty I*, which participated in the RoboCup 2014 humanoid AdultSize league in Brazil. As an example Figure 11 shows the design of the rod-and-lever systems on the feet of *Sweaty I* using Dynamixel MX-106 motors. This mechanical design has two further advantages:

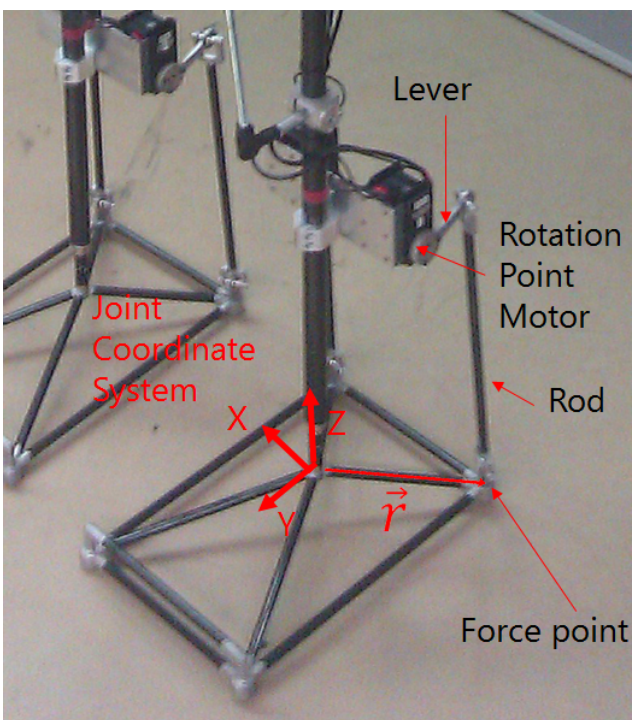

Fig. 11. Rod-and-lever systems on the feet of *Sweaty I*

- Low moment of inertia: The actuators are located close to the previous joint of the kinematic chain. This reduces the moment of inertia with respect to the center of mass and thus the load on previous actuators.
- The parallel kinematics results in a small moving mass and the forces of the motors add up.

B. *Sweaty II*

With the insights gained from the analysis of human motion behavior, a completely new version of a rod-and-

lever actuated robot is currently designed, called *Sweaty II*, which is shown in Figure 12.



Fig. 12. Design prototype of *Sweaty II* - not yet optimized for light weight

The design and manufacturing of the feet and knees are finished for prototype testing, the hip is still being designed. The arms shown are from *Sweaty I*. The cameras for the vision are moved with a new drive system including a magnetic protection mechanism to prevent damage to the vision components during a fall.

The main difference between *Sweaty I* and *II* are the actuators. *Sweaty II* uses ball screw spindle motors instead of Dynamixel motors. These enable a more compact design. In addition the selected motors have much more power than the Dynamixel motors. The design is shown in Figure 13, where the foot is moved by two motors mounted parallel. The drives always work together and provide a high torque for the movements. Both spindle rods are attached by a 2-DoF universal joint on each side. The main joint of the foot is also a 2-DoF universal joint.

C. *Mappings by the Motion Controller*

A rod-and-lever based joint actuation requires an additional mapping layer as part of the controller software architecture. It relates joint angles to servo motor angles. The mapping has to be done in both directions. Actuation



Fig. 13. Design of the foot of Sweaty II

commands to the servos have to be mapped from joint to motor angles while readings from the servos have to be translated from motor to joint angles.

For the foot of Sweaty II forward mapping from joint to motor angles is done as follows (shown for the left motor in Figure 11): The point of effort \vec{r} is rotated from its initial position in the joint coordinate system to the final position \vec{r}' by rotation matrices corresponding to the pitch and roll angles $\vec{r}' = R_{\text{roll}}R_{\text{pitch}}\vec{r}$.

To analyze the readings from sensors, inverse mapping from motor to joint angles is also required. This is realized by look-up tables. The tables are generated by using a solver based on the forward mapping. For the look-up tables a three-fold linear interpolation of the pitch and roll look-up angles is used.

In fact, since the use of look-up tables is about 4 to 5 times faster than calculating the values every time (on Ubuntu 14.04 on an i7-4710HQ with 16 GiB RAM), look-up tables are also used for the forward mapping. The mapping for the hip uses the same concept, but with rotations for the pitch, roll and yaw angles. The mapping for the knee is directly calculated for the forward and the backward direction.

V. CONCLUSION AND FUTURE WORK

We have analyzed motion capture data to identify the ranges of joint angles and angular velocities necessary for a human-like gait. In addition the torque provided should be large enough so that the robot can squat to a certain extent.

Based on these results lower limbs for Sweaty II, successor to Sweaty I, were designed using electric drives and ball screws. Temporarily the motors will be overloaded thermally to enable movements which are fast and energetic enough. The mechanical stress in the structure of the robot never exceeds its limits even for a fast walk. A purpose-built motor controller had to be developed to be able to overload the electrical motor temporarily, in combination with evaporative cooling. This controller unit is able to move the legs and feet according to the gait we extracted from motion capture data.

The analysis of motion capture data is not sufficient to design a robot for a human-like gait. Especially torque values required for high dynamic movements cannot explicitly be extracted from motion capture data. A multi-body simulation for the robot was used and will be refined to get more information about the relation between the angular velocity of a joint and the torque. For this an interface to a CAD program is under development to obtain information about the weight, the center of mass, the inertia tensors for different joint positions and orientations. Current work also concerns the simulation of the contact forces between the feet and the ground. For Sweaty II a new hip is being designed by using rod-and-lever systems with ball screw actuators as in the case of the knees and feet.

ACKNOWLEDGMENT

The authors would like to thank the Hochschule Offenburg for the financial support of the project as well as maxon motor GmbH for their sponsorship.

REFERENCES

- [1] S. Behnke, M. Schreiber, J. Stuckler, R. Renner, and H. Strasdat, "See, walk, and kick: Humanoid robots start to play soccer," in *Humanoid Robots, 2006 6th IEEE-RAS International Conference on Humanoid Robots*, 2006, pp. 497–503.
- [2] Robocup Federation, "Robocup soccer humanoid league teams 2015," <https://www.robocuphumanoid.org/hl-2015/teams/>, last visited: 2015-10-01.
- [3] Boston Dynamics, "Atlas anthropomorphic robot," http://archive.darpa.mil/roboticschallenge/trialsarchive/files/ATLAS-Datasheet_v15_DARPA.PDF, last visited: 2015-10-01.
- [4] C. Mandery, O. Terlemez, M. Do, N. Vahrenkamp, and T. Asfour, "The KIT whole-body human motion database," in *International Conference on Advanced Robotics (ICAR)*, 2015, pp. 329–336.
- [5] O. Terlemez, S. Ulbrich, C. Mandery, M. Do, N. Vahrenkamp, and T. Asfour, "Master motor map (MMM) - framework and toolkit for capturing, representing, and reproducing human motion on humanoid robots," in *IEEE/RAS International Conference on Humanoid Robots (Humanoids)*, 2014, pp. 894–901.
- [6] T. Buschmann, S. Lohmeier, and H. Ulbrich, "Humanoid robot Lola: Design and walking control," *Journal of Physiology-Paris*, vol. 103, no. 3-5, pp. 141 – 148, 2009, neurorobotics. [Online]. Available: <http://www.sciencedirect.com/science/article/pii/S0928425709000400>
- [7] L. Ryoo, "Mechanical horse," US Patent 491 927, 1893.
- [8] S. Lohmeier, T. Buschmann, and H. Ulbrich, "Humanoid robot LOLA," in *Robotics and Automation, 2009. ICRA '09. IEEE International Conference on Robotics and Automation*, May 2009, pp. 775–780.
- [9] U. Hochberg, A. Dietsche, and K. Dorer, "Evaporative cooling of actuators for humanoid robots," in *Proceedings of the 8th Workshop on Humanoid Soccer Robots, Atlanta*, 2013.